

LUCAS

001 / 21/07/2023

CABINET 2D HHS

ART CODE: 440 23 201

bopita®

"BOPITA"
LION INTERNATIONAL B.V.
ENERGIEWEG 1
6662 NS ELST GLD
NEDERLAND
www.bopita.com

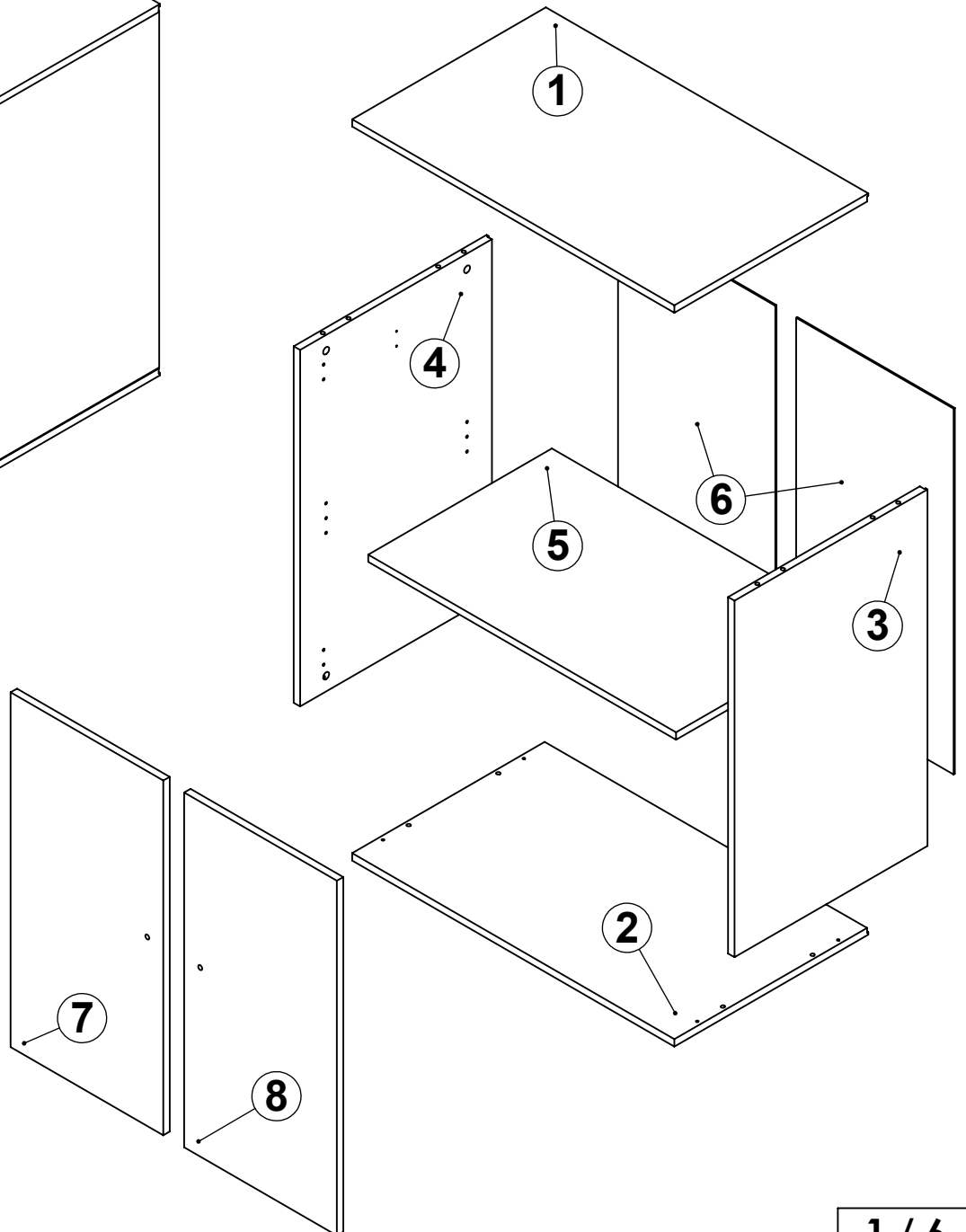
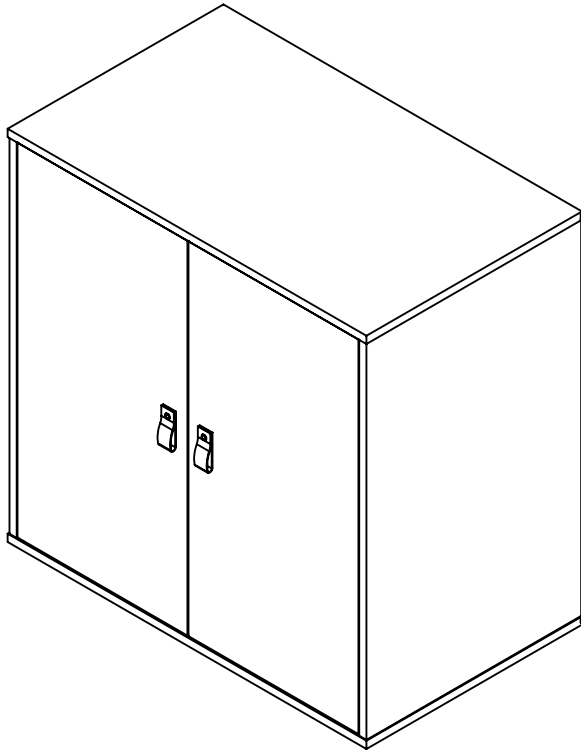

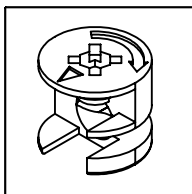
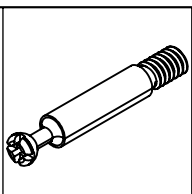
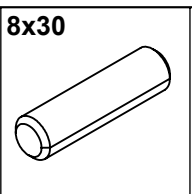
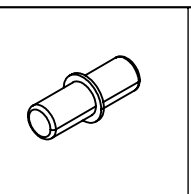
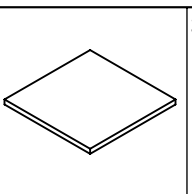
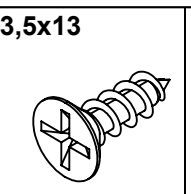
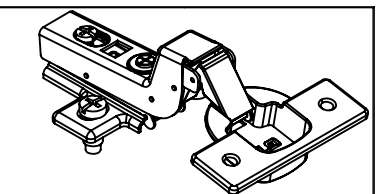
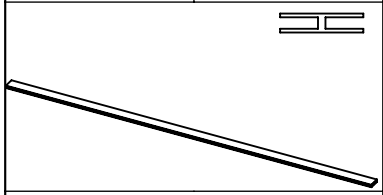
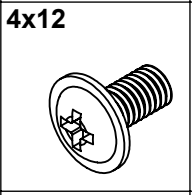
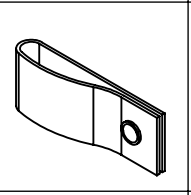
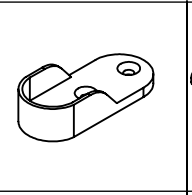
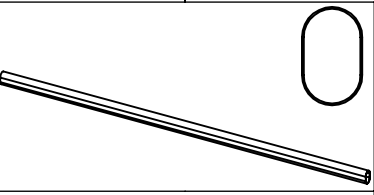
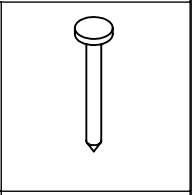
		8x30 			3,5x13 	
A x 8	B x 8	C x 8	D x 4	E x 4	F x 12	G1/G2 x 2/2
		4x12 				
H x 1		I x 2	J x 2	K x 2	L x 3	M x 24

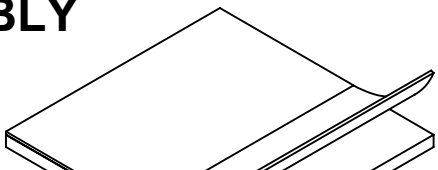

IMBUS

BEFORE ASSEMBLY

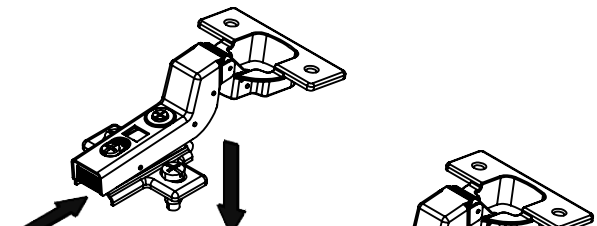

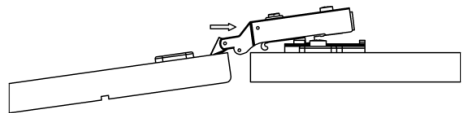

PRESS

"A"

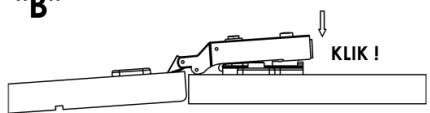

"B"

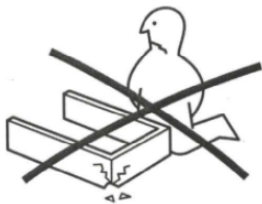
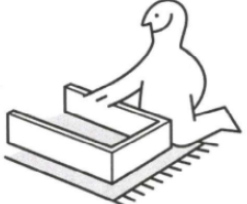



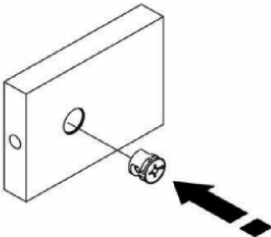
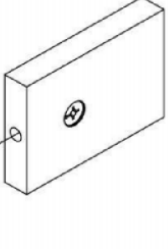

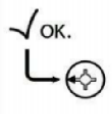

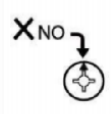

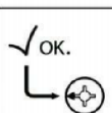
✓ OK.

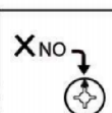
X NO

✓ OK.

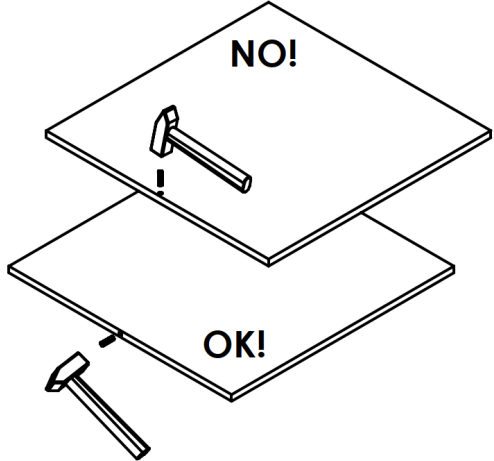
X NO



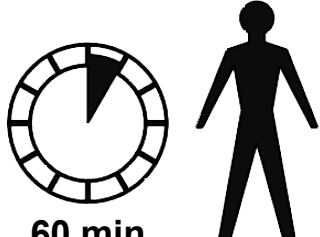

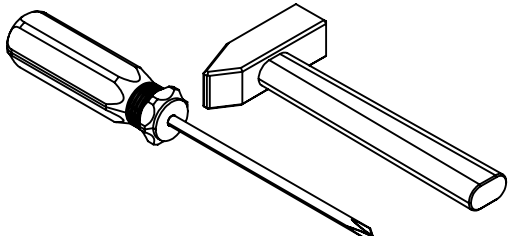
60 min.

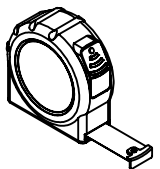

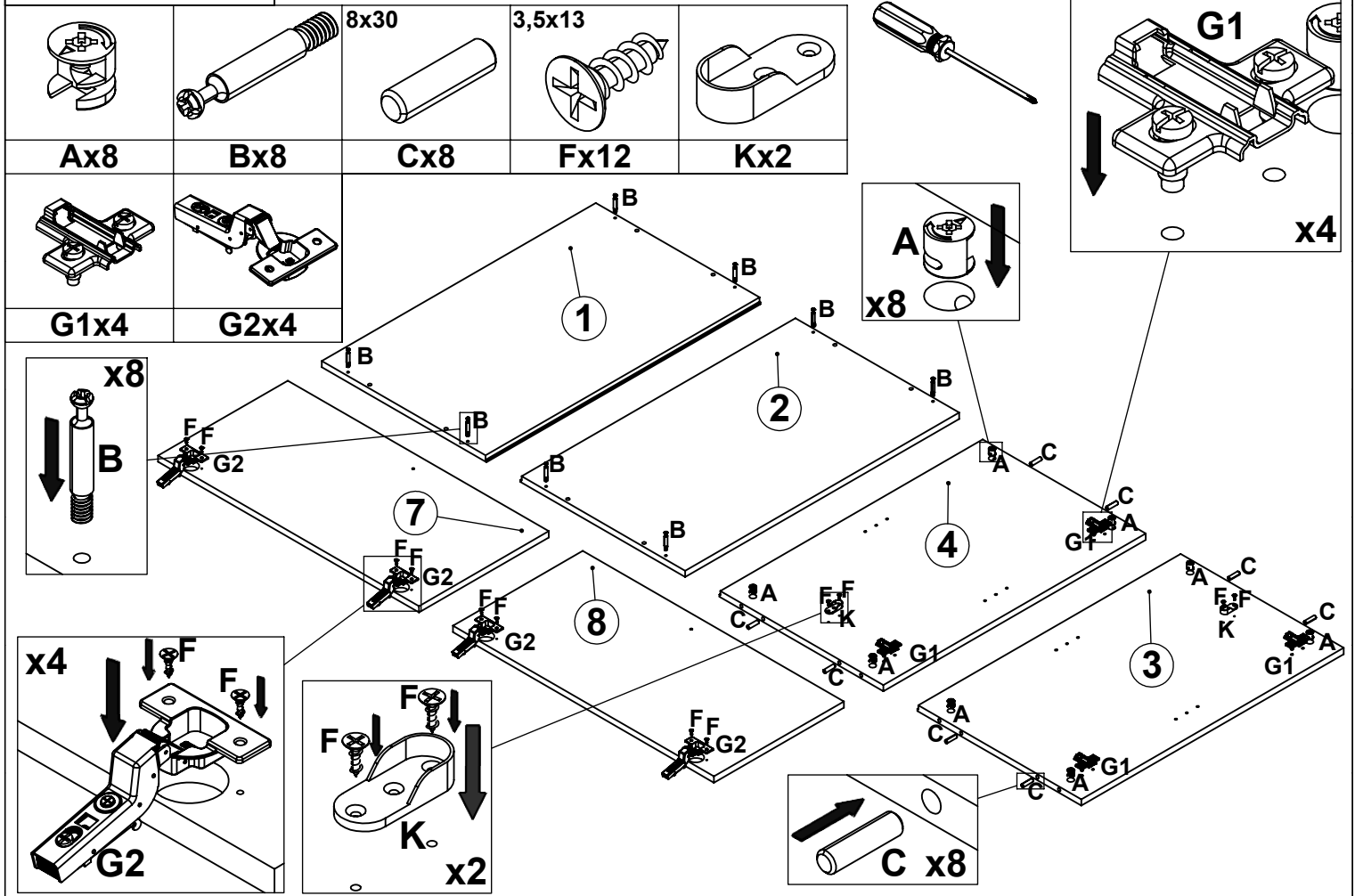

2 / 6

STEP - 1



STEP - 2

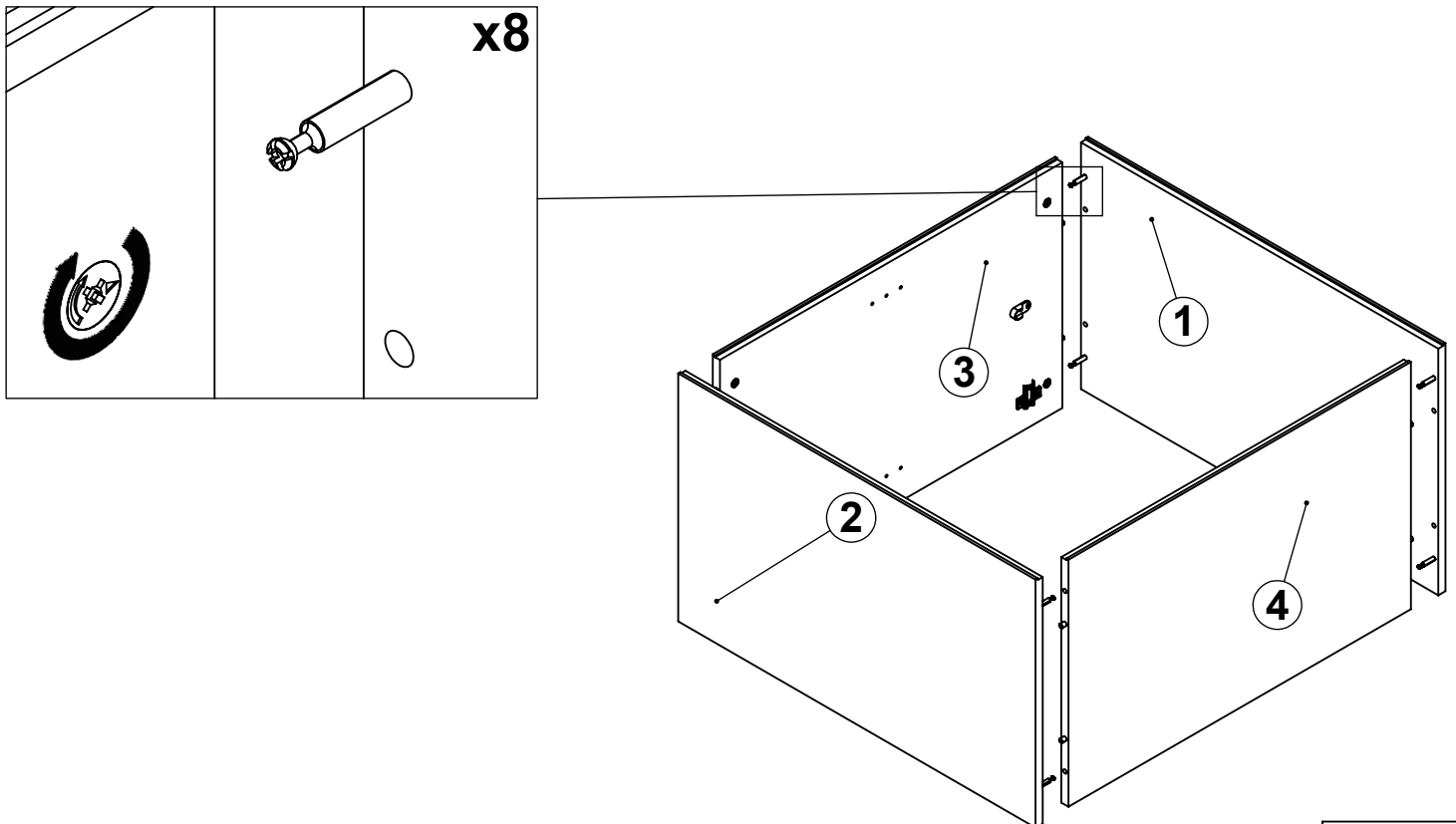

STEP - 3

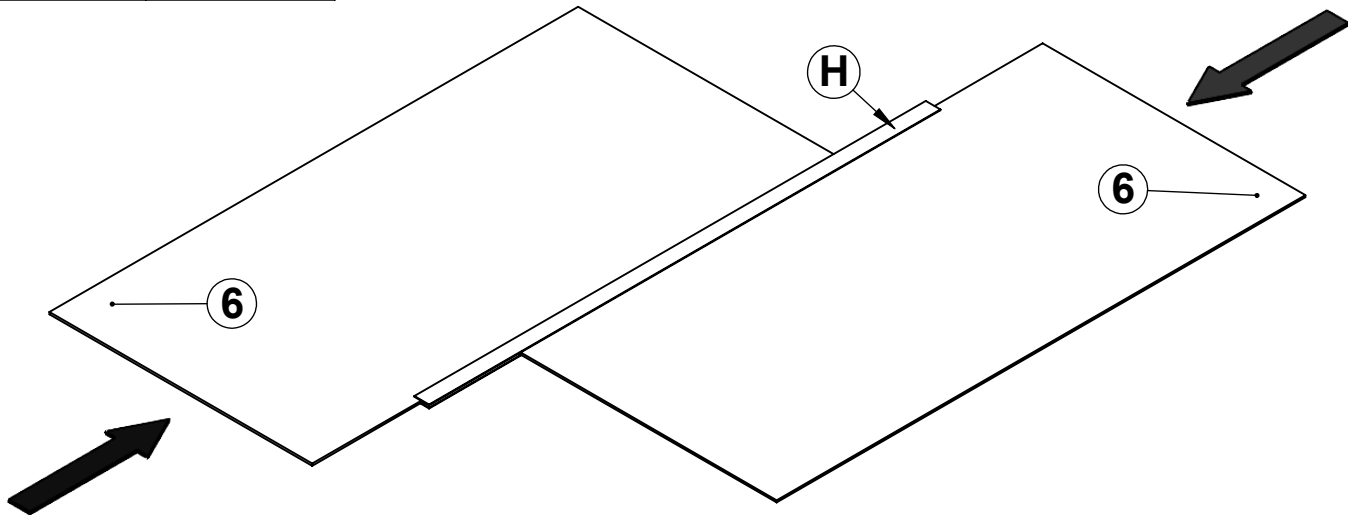
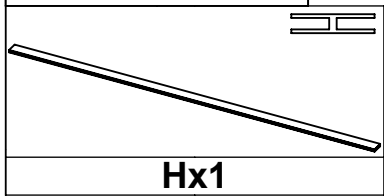

STEP - 4

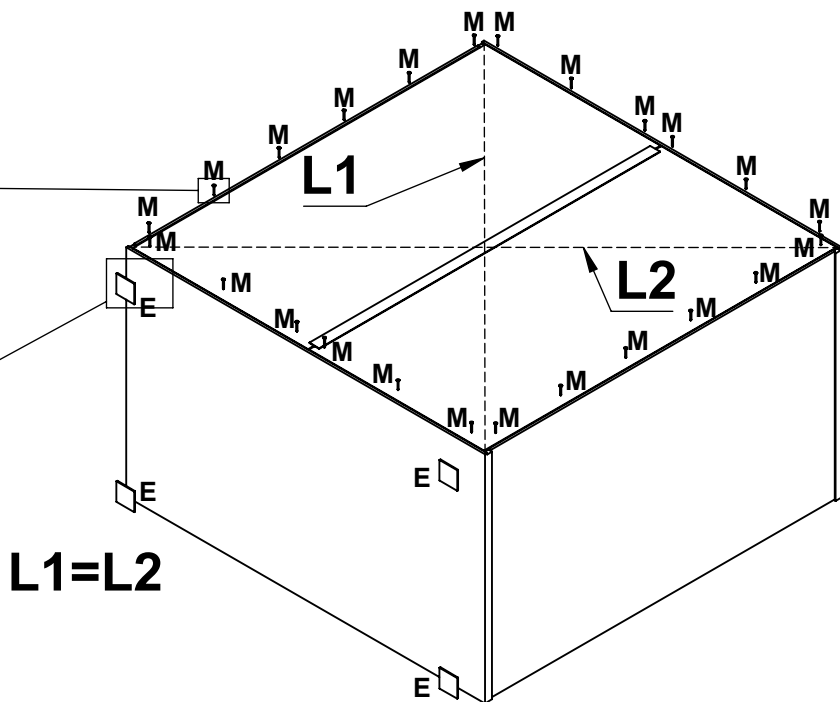
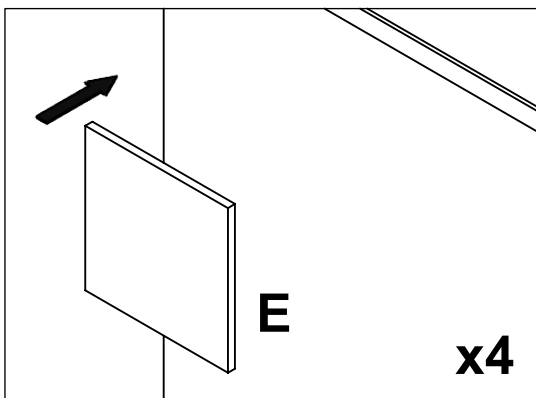
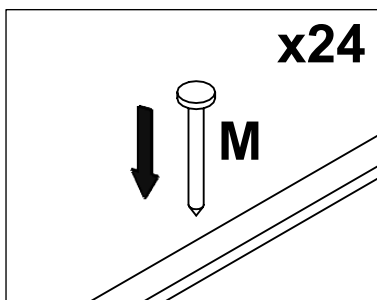
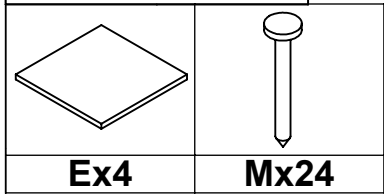

STEP - 5

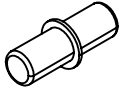

Dx4

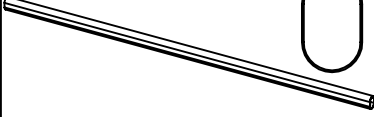

Lx1

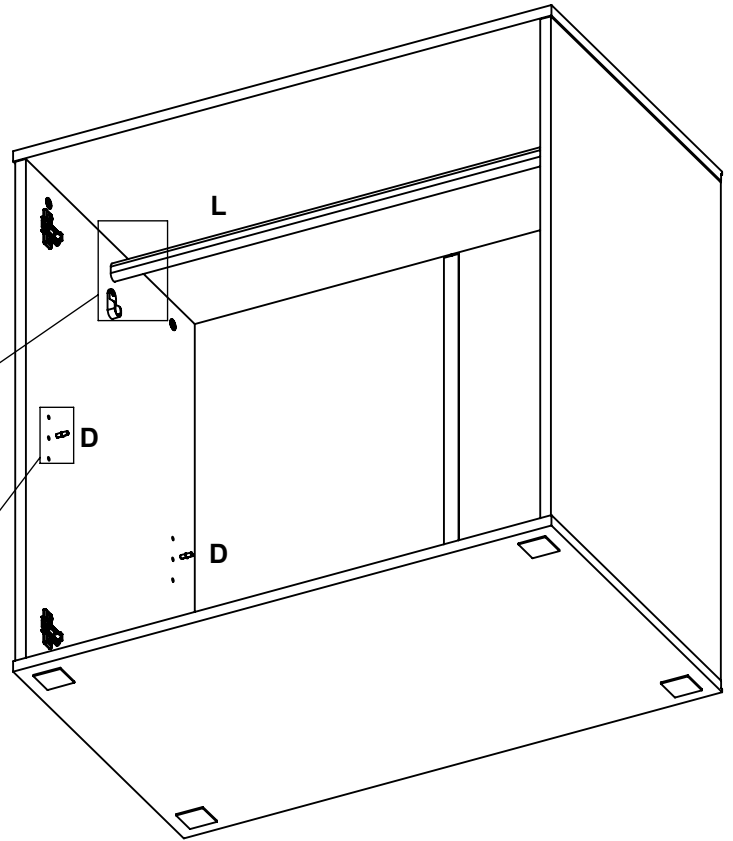
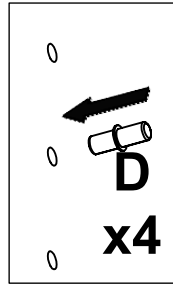
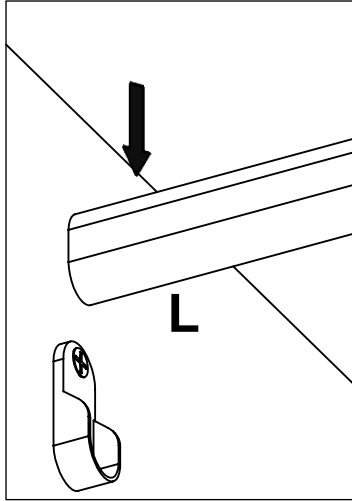

STEP - 6

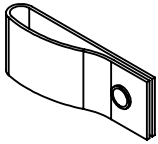

Ix2

4x12

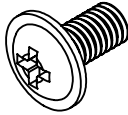

Jx2

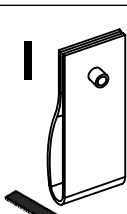
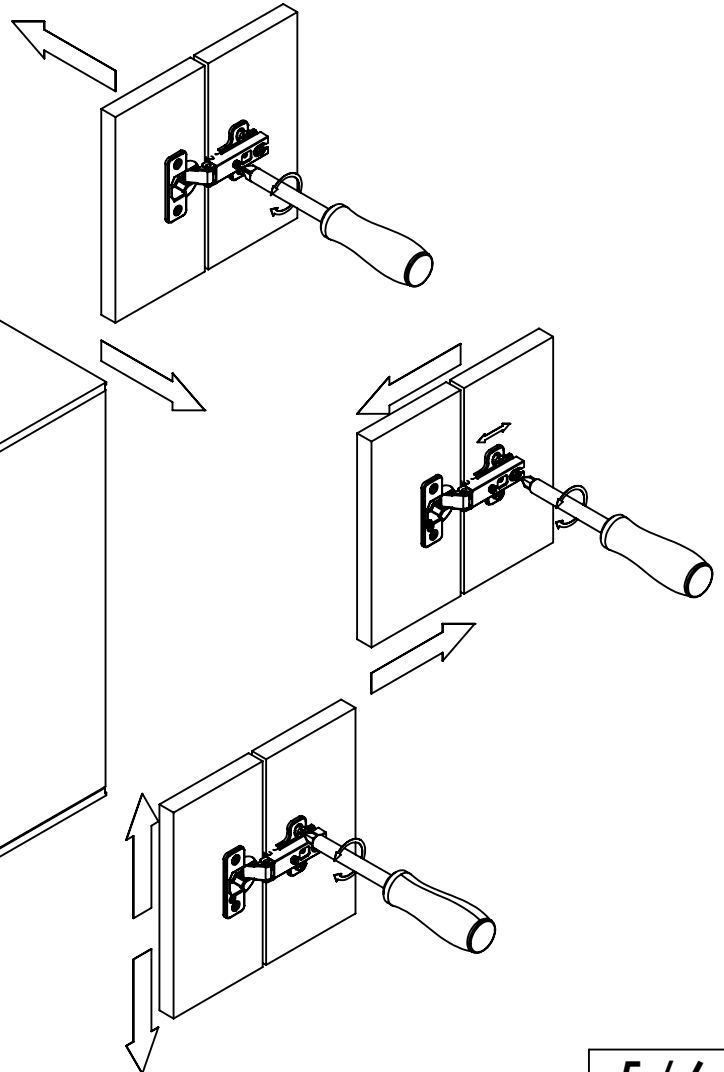
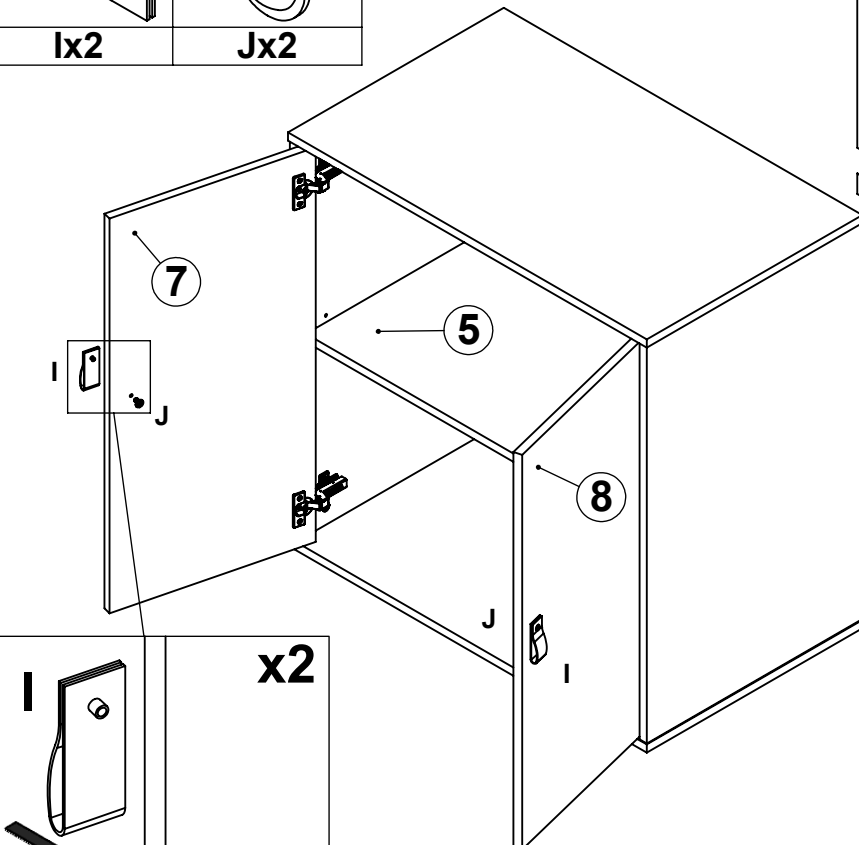

x2



QC-CODE

(UK) for service requests

(NL) voor service vragen

(FR) pour les demandes de service

(DE) für Service Anfragen

(ES) para consultas de servicio

(IT) per richieste di assistenza

